

EOLS-1303-2M Series

**Multi-Mode 1310nm 100M/155M SDH/SONET
Duplex SFP Transceiver
RoHS6 Compliant**

Features

- ◆ Operating Data Rate up to 155Mbps
- ◆ 1310nm FP Laser Transmitter
- ◆ 2km with 50/125 μm MMF
1km with 62.5/125 μm MMF
- ◆ Single 3.3V Power Supply and TTL Logic Interface
- ◆ Hot-Pluggable SFP Footprint Duplex LC Connector Interface
- ◆ Class 1 FDA and IEC60825-1 Laser Safety Compliant
- ◆ Operating Temperature
Standard: 0~+70
Industrial:-40~+85
- ◆ Compliant with MSA SFP Specification
- ◆ Digital Diagnostic Monitor Interface Compatible with SFF-8472



Applications

- ◆ SDH STM-1, I-1.1
- ◆ SONET OC-3 SR1
- ◆ Fast Ethernet
- ◆ Other Optical Links

Ordering Information

Part No.	Data Rate	Fiber	Distance *(note2)	Interface	Temperature	DDMI
EOLS-1303-2M*(note1)	155Mbps	MMF	2km	LC	Standard	NO
EOLS-1303-2MI	155Mbps	MMF	2km	LC	Industrial	NO
EOLS-1303-2MD	155Mbps	MMF	2km	LC	Standard	YES
EOLS-1303-2MDI	155Mbps	MMF	2km	LC	Industrial	YES

Note1: Standard version

Note2: 2Km with 50/125 μm MMF

Regulatory Compliance

Feature	Standard	Performance
Electrostatic Discharge (ESD) to the Electrical Pins	MIL-STD-883G Method 3015.7	Class 1C (>1000 V)
Electrostatic Discharge to the enclosure	EN 55024:1998+A1+A2 IEC-61000-4-2 GR-1089-CORE	Compliant with standards
Electromagnetic Interference (EMI)	FCC Part 15 Class B EN55022:2006 CISPR 22B :2006 VCCI Class B	Compliant with standards Noise frequency range: 30MHz to 6GHz. Good system EMI design practice required to achieve Class B margins. System margins are dependent on customer host board and chassis design.
Immunity	EN 55024:1998+A1+A2 IEC 61000-4-3	Compliant with standards. 1KHz sine-wave, 80% AM, from 80MHz to 1GHz. No effect on transmitter/receiver performance is detectable between these limits.
Laser Eye Safety	FDA 21CFR 1040.10 and 1040.11 EN (IEC) 60825-1:2007 EN (IEC) 60825-2:2004+A1	CDRH compliant and Class I laser product. TüV Certificate No. 50135086
Component Recognition	UL and CUL EN60950-1:2006	UL File E317337 TüV Certificate No. 50135086 (CB scheme)
RoHS6	2002/95/EC 4.1&4.2 2005/747/EC 5&7&13	Compliant with standards ^{*note3}

Note3: For update of the equipments and strict control of raw materials, EOPTOLINK has the ability to supply the customized products since Jan 1st, 2007, which meet the requirements of RoHS6 (Restrictions on use of certain Hazardous Substances) of European Union.

In light of item 5 in RoHS exemption list of RoHS Directive 2002/95/EC, Item 5: Lead in glass of cathode ray tubes, electronic components and fluorescent tubes.

In light of item 7 in RoHS exemption list of RoHS Directive 2005/747/EC, Item 7: Lead in high melting temperature type solders (i.e. lead-based alloys containing 85% by weight or more lead). Lead in solder for servers, storage and storage array systems, network infrastructure equipment for switching, signaling, transmission as well as network management for telecommunications. Lead in electronic ceramic parts (e.g. piezoelectronic devices).

In light of item 13 in RoHS exemption list of RoHS Directive 2005/747/EC, Item 13: Lead and cadmium in optical and filter glass. The three exemptions are being concerned for Eoptolink's transceivers, because Eoptolink's

transceivers use glass, which may contain Pb, for components such as lenses, isolators, and other components.

Product Description

The EOLS-1303-2M series transceiver is small form factor pluggable module for duplex optical data communications such as Fast Ethernet and OC-3/STM-1 SDH/SONET. It is with the SFP 20-pin connector to allow hot plug capability. This module is designed for multi-mode fiber and operates at a nominal wavelength of 1310 nm.

The transmitter section uses a multiple quantum well 1310nm laser and is a class 1 laser compliant according to International Safety Standard IEC 60825. The receiver section uses an integrated GaAs detector preamplifier (IDP) mounted in an optical header and a limiting post-amplifier IC.

The EOLS-1303-2MD series are designed to be compliant with SFF-8472 SFP Multi-source Agreement (MSA).

Absolute Maximum Ratings

Parameter	Symbol	Min.	Max.	Unit
Storage Temperature	TS	-40	+85	°C
Supply Voltage	VCC	-0.5	3.6	V
Operating Relative Humidity		-	95	%

*Exceeding any one of these values may destroy the device immediately.

Recommended Operating Conditions

Parameter	Symbol	Min.	Typical	Max.	Unit	
Operating Case Temperature	TA	EOLS-1303-2M	0		+70	°C
		EOLS-1303-2MI	-40		+85	
Power Supply Voltage	Vcc	3.15	3.3	3.45	V	
Power Supply Current	Icc			300	mA	
Data Rate	OC-3/STM-1		155		Mbps	
	100M		100			

Performance Specifications - Electrical

Parameter	Symbol	Min.	Typ.	Max	Unit	Notes
Transmitter						
LVPECL Inputs(Differential)	Vin	400		2000	mVpp	AC Coupled Inputs*(note3)
Input Impedance (Differential)	Zin	85	100	115	ohms	Rin > 100 kohms @ DC
TX_Dis	Disable	2		Vcc+0.3	V	
	Enable	0		0.8		
TX_FAULT	Fault	2		Vcc+0.3	V	

	Normal		0		0.5		
Receiver							
LVPECL Outputs (Differential)		Vout	400		2000	mVpp	AC Coupled Outputs ^{*(note3)}
Output Impedance (Differential)		Zout	85	100	115	ohms	
RX_LOS	LOS		2		Vcc+0.3	V	
	Normal		0		0.8	V	
MOD_DEF (0:2)		VoH	2.5			V	With Serial ID
		VoL	0		0.5	V	

Optical and Electrical Characteristics

Parameter	Symbol	Min.	Typical	Max.	Unit
50µm Core Diameter MMF	L		2		km
Data Rate			100/155		Mbps
Transmitter					
Center Wavelength	λ_c	1260	1310	1360	nm
Spectral Width (RMS)	$\Delta\lambda$			10	nm
Average Output Power ^{*(note4)}	Pout	-19		-12	dBm
Extinction Ratio ^{*(note5)}	ER	8.2			dB
Rise/Fall Time(20%~80%)	tr/tf			3	ns
Total Jitter ^{*(note5)}	TJ			1	ns
Output Optical Eye ^{*(note5)}	Telcordia GR-253-CORE and IUT-T G.957 Compliant ^{*(note7)}				
TX_Disable Assert Time	t_off			10	µs
Receiver					
Center Wavelength	λ_c	1260		1600	nm
Receiver Sensitivity ^{*(note6)}	Pmin			-30	dBm
Receiver Overload	Pmax	-8			dBm
Return Loss		14			dB
LOS De-Assert	LOSD			-31	dBm
LOS Assert	LOSA	-45			dBm
LOS Hysteresis ^{*(note8)}		0.5			dB

Note3: LVPECL logic, internally AC coupled.

Note4: Output power is measured by coupling into a 62.5/125 mm multi-mode fiber.

Note5: Filtered, measured with a PRBS 2²³-1 test pattern @155Mbps

Note6: Minimum average optical power is measured by coupling into a 62.5/125 mm multi-mode fiber; the BER is less than 1E-10 or lower, measured with a 2²³-1 NRZ PRBS and ER=9 dB.

Note8: Eye Pattern Mask

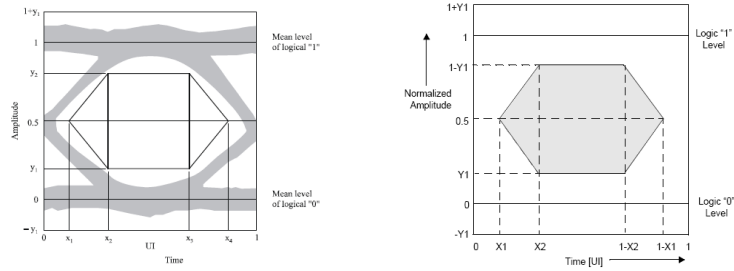

Note9: LOS Hysteresis

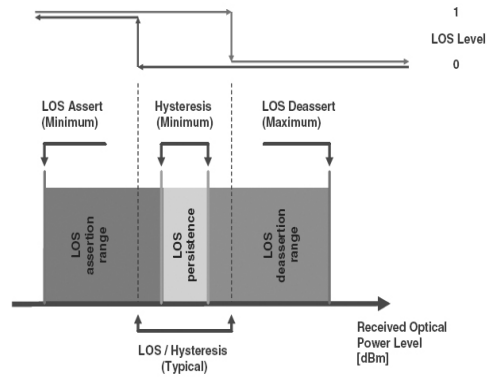

Functional Description of Transceiver

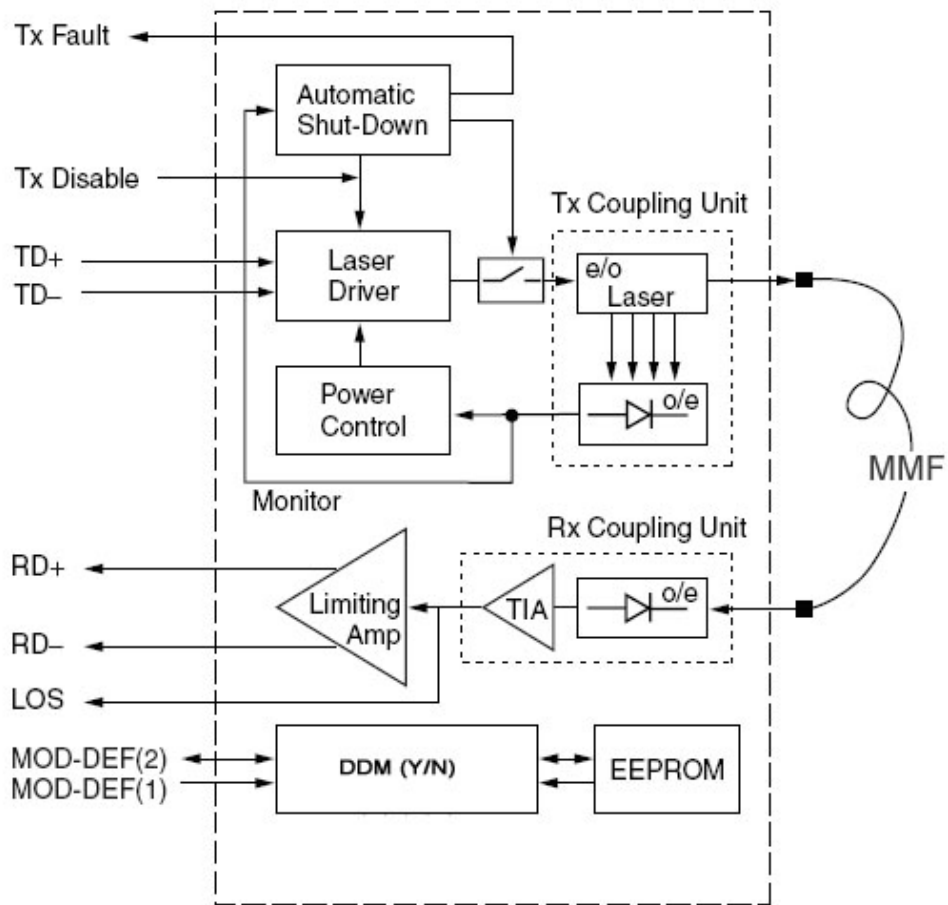

SFP Transceiver Electrical Pad Layout

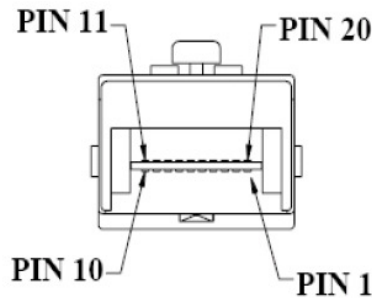
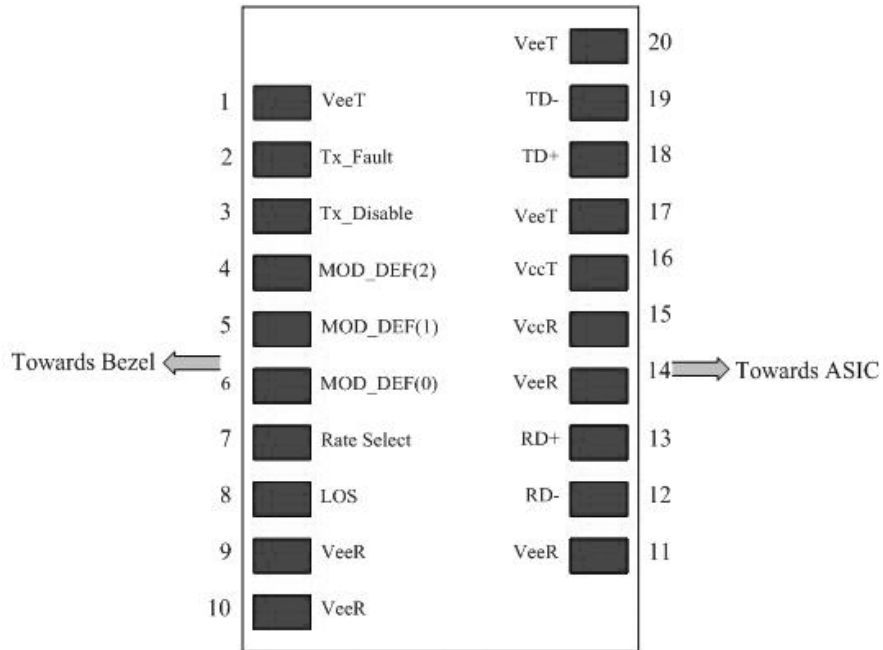

Pin Function Definitions

Pin Num.	Name	Function	Plug Seq.	Notes
1	VeeT	Transmitter Ground	1	
2	TX Fault	Transmitter Fault Indication	3	1)
3	TX Disable	Transmitter Disable	3	2) Module disables on high or open
4	MOD-DEF2	Module Definition 2	3	3) Data line for Serial ID.
5	MOD-DEF1	Module Definition 1	3	3) Clock line for Serial ID.
6	MOD-DEF0	Module Definition 0	3	3) Grounded within the module.
7	Rate Select	Not Connect	3	Function not available
8	LOS	Loss of Signal	3	4)

9	VeeR	Receiver Ground	1	5)
10	VeeR	Receiver Ground	1	5)
11	VeeR	Receiver Ground	1	5)
12	RD-	Inv. Received Data Out	3	6)
13	RD+	Received Data Out	3	6)
14	VeeR	Receiver Ground	1	5)
15	VccR	Receiver Power	2	7) 3.3 ± 5%
16	VccT	Transmitter Power	2	7) 3.3 ± 5%
17	VeeT	Transmitter Ground	1	5)
18	TD+	Transmit Data In	3	8)
19	TD-	Inv. Transmit Data In	3	8)
20	VeeT	Transmitter Ground	1	5)

Notes:

1) TX Fault is an open collector/drain output, which should be pulled up with a 4.7K – 10KΩ resistor on the host board. Pull up voltage between 2.0V and VccT, R+0.3V. When high, output indicates a laser fault of some kind. Low indicates normal operation. In the low state, the output will be pulled to < 0.8V.

2) TX disable is an input that is used to shut down the transmitter optical output. It is pulled up within the module with a 4.7 – 10 KΩ resistor. Its states are:

Low (0 – 0.8V): Transmitter on

(>0.8, < 2.0V): Undefined

High (2.0 – 3.465V): Transmitter Disabled

Open: Transmitter Disabled

3) Modulation Absent, connected to VEET or VEER in the module.

4) LOS (Loss of Signal) is an open collector/drain output, which should be pulled up with a 4.7K – 10KΩ resistor. Pull up voltage between 2.0V and VccT, R+0.3V. When high, this output indicates the received optical power is below the worst-case receiver sensitivity (as defined by the standard in use). Low indicates normal operation. In the low state, the output will be pulled to < 0.8V.

5) VeeR and VeeT may be internally connected within the SFP module.

6) RD-/+ : These are the differential receiver outputs. They are AC coupled 100Ω differential lines which should be terminated with 100Ω (differential) at the user SERDES. The AC coupling is done inside the module and is thus not required on the host board. The voltage swing on these lines will be between 400 and 2000 mV differential (200 –1000 mV single ended) when properly terminated.

7) VccR and VccT are the receiver and transmitter power supplies. They are defined as 3.3V ±5% at the SFP connector pin. Maximum supply current is 300mA. Recommended host board power supply filtering is shown below. Inductors with DC resistance of less than 1 ohm should be used in order to maintain the required voltage at the SFP input pin with 3.3V supply voltage.

When the recommended supply-filtering network is used, hot plugging of the SFP transceiver module will result in an inrush current of no more than 30mA greater than the steady state value. VccR and VccT may be internally connected within the SFP transceiver module.

8) TD-/+: These are the differential transmitter inputs. They are AC-coupled, differential lines with 100Ω differential termination inside the module. The AC coupling is done inside the module and is thus not required on the host board. The inputs will accept differential swings of 400 – 2000mV (200 – 1000mV single-ended).

EEPROM

The serial interface uses the 2-wire serial CMOS EEPROM protocol defined for the ATMEL AT24C02/04 family of components. When the serial protocol is activated, the host generates the serial clock signal (SCL). The positive edge clocks data into those segments of the EEPROM that are not writing protected within the SFP transceiver. The negative edge clocks data from the SFP transceiver. The serial data signal (SDA) is bi-directional for serial data transfer. The host uses SDA in conjunction with SCL to mark the start and end of serial protocol activation. The memories are organized as a series of 8-bit data words that can be addressed individually or sequentially.

The Module provides diagnostic information about the present operating conditions. The transceiver generates this diagnostic data by digitization of internal analog signals. Calibration and alarm/warning threshold data is written during device manufacture. Received power monitoring, transmitted power monitoring, bias current monitoring, supply voltage monitoring and temperature monitoring all are implemented. If the module is defined as external calibrated, the diagnostic data are raw A/D values and must be converted to real world units using calibration constants stored in EEPROM locations 56 – 95 at wire serial bus address A2h. The digital diagnostic memory map specific data field define as following .For detail EEPROM information, please refer to the related document of SFF 8472 Rev 9.3.

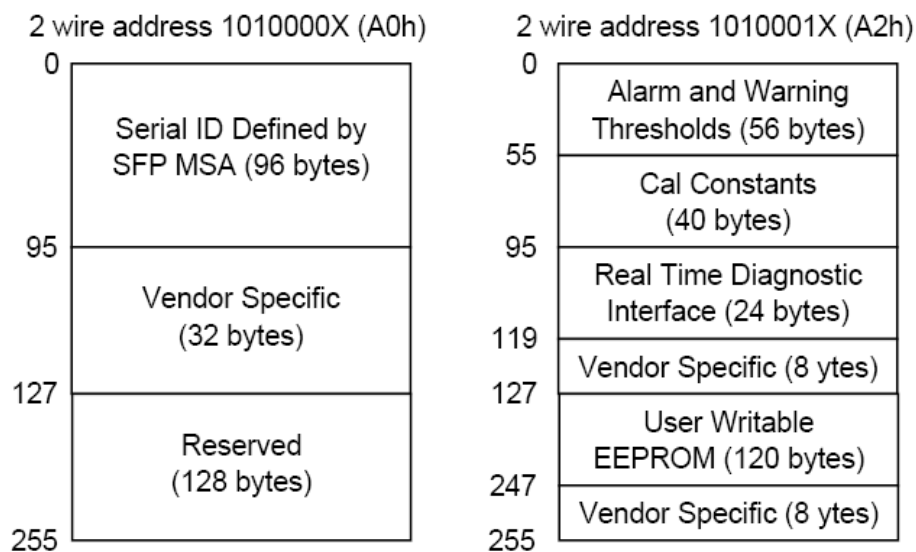

EEPROM Serial ID Memory Contents

Accessing Serial ID Memory uses the 2 wire address 1010000X (A0H). Memory Contents of Serial ID are shown in Table 1.

Table 1 Serial ID Memory Contents

Addr.	Size (Bytes)	Name of Field	Hex	Description
BASE ID FIELDS				
0	1	Identifier	03	SFP
1	1	Ext. Identifier	04	SFP function is defined by serial ID only
2	1	Connector	07	LC Connector
3-10	8	Transceiver	00 00 00 20 00 00 00 00	100BASE-FX
11	1	Encoding	02	4B5B
12	1	BR, Nominal	01	100BASE-FX
13	1	Reserved	00	
14	1	Length (9μm)km		Transceiver transmit distance
15	1	Length(9μm)100m		
16	1	Length (50μm) 10m	C8	
17	1	Length(62.5μm)10m	64	
18	1	Length (Copper)	00	Not compliant
19	1	Reserved	00	
20-35	16	Vendor name	45 4F 50 54 4F 4C 49 4E 4B 20 20 20 20 20 20 20 20	EOPTOLINK (ASCII)
36	1	Reserved	00	
37-39	3	Vendor OUI	XX XX XX ^(note10)	
40-55	16	Vendor PN		Vendor part number
56-59	4	Vendor rev	XX XX XX XX ^(note10)	
60-61	2	Wavelength	05 1E	1310nm
62	1	Reserved	00	
63	1	CC_BASE	Check Sum (Variable)	Check code for Base ID Fields
EXTENDED ID FIELDS				
64-65	2	Options	00 1A	TX_DISABLE, TX_FAULT and Loss of Signal implemented.
66	1	BR,max	00	
67	1	BR,min	00	
68-83	16	Vendor SN	XX XX XX XX XX XX XX XX XX20 20 20 20 20	Serial Number of transceiver (ASCII). For

			20 20 20 ^(note10)	example "B000822".
84-91	8	Date code	XX XX XX XX XX XX XX XX ^(note10)	Manufactory date code. For example "080405".
92	1	Diagnostic Monitoring Type	XX ^(note10)	Digital diagnostic monitoring implemented
93	1	Enhanced Options	XX ^(note10)	Optional flags
94	1	SFF_8472 Compliance	XX ^(note10)	01 for diagnostics (Rev9.3 SFF-8472).
95	1	CC_EXT	Check Sum (Variable)	Check sum for Extended ID Field.
VENDOR SPECIFIC ID FIELDS				
96-127	32	Vendor Specific	Read only	Depends on customer information
128-255	128	Reserved	Read only	

Note10: The "xx" byte should be filled in according to practical case. For more information, please refer to the related document of SFP Multi-Source Agreement (MSA).

Digital Diagnostic Monitoring Interface (2-Wire Address A2H)

Alarm and Warning Thresholds (2 Wire Address A2H)

Address	# Bytes	Name of Field	HEX	Real Value	Unit
00-01	2	Temp High Alarm	6E 00	110	Degree C
02-03	2	Temp Low Alarm	D3 00	-45	Degree C
04-05	2	Temp High Warning	5F 00	95	Degree C
06-07	2	Temp Low Warning	D3 00	-42	Degree C
08-09	2	Voltage High Alarm	8C A0	3.6	V
10-11	2	Voltage Low Alarm	71 48	2.9	V
12-13	2	Voltage High Warning	88 B8	3.5	V
14-15	2	Voltage Low Warning	0B B8	3.0	V
16-17	2	Bias High Alarm	88 B8	70	mA
18-19	2	Bias Low Alarm	03 E8	2	mA
20-21	2	Bias High Warning	75 30	60	mA
22-23	2	Bias Low Warning	05 DC	3	mA
24-25	2	TX Power High Alarm			dBm
26-27	2	TX Power Low Alarm			dBm
28-29	2	TX Power High Warning			dBm
30-31	2	TX Power Low Warning			dBm
32-33	2	RX Power High Alarm			dBm
34-35	2	RX Power Low Alarm			dBm
36-37	2	RX Power High Warning			dBm
38-39	2	RX Power Low Warning	00 13		dBm
40-55	16	Reserved			

Calibration Constants (2 Wire Address A2H)

Address	# Bytes	Name of Field	HEX	Description
56-59	4	RX_PWR (4)	00 00 00 00	Set to zero for “internally calibrated” devices.
60-63	4	RX_PWR (3)	00 00 00 00	Set to zero for “internally calibrated” devices.
64-67	4	RX_PWR (2)	00 00 00 00	Set to zero for “internally calibrated” devices.
68-71	4	RX_PWR (1)	3F 80 00 00	Set to 1 for “internally calibrated” devices.
72-75	4	RX_PWR (0)	00 00 00 00	Set to zero for “internally calibrated” devices.
76-77	2	TX_I (Slope)	01 00	Set to 1 for “internally calibrated” devices.
78-79	2	TX_I (Offset)	00 00	Set to zero for “internally calibrated” devices.
80-81	2	TX_PWR (Slope)	01 00	Set to 1 for “internally calibrated” devices.
82-83	2	TX_PWR (Offset)	00 00	Set to zero for “internally calibrated” devices.
84-85	2	T (Slope)	01 00	Set to 1 for “internally calibrated” devices.
86-87	2	T (Offset)	00 00	Set to zero for “internally calibrated” devices.
88-89	2	V (Slope)	01 00	Set to 1 for “internally calibrated” devices.
90-91	2	V (Offset)	00 00	Set to zero for “internally calibrated” devices.
92-94	3	Reserved	00 00 00	Reserved
95	1	Checksum	XX	Checksum of bytes 0 – 94.

A/D Value (2 Wire Address A2H)

Address	# Bytes	Name of Field	Description
96-97	2	Temperature (MSB, LSB)	Internally measured module temperature
98-99	2	Supply Voltage (MSB, LSB)	Internally measured supply voltage in module
100-101	2	TX Bias Current (MSB, LSB)	Internally measured Tx Bias current
102-103	2	TX Optical Power (MSB, LSB)	Internally measured Tx Optical Power
104-105	2	RX Received Power (MSB, LSB)	Measured RX input power
106-109	4	Reserved	

*Temperature (Signed twos complement value)

A2H Byte 96 (Temperature MSB)								A2H Byte 97 (Temperature LSB)							
S	2 ⁶	2 ⁵	2 ⁴	2 ³	2 ²	2 ¹	2 ⁰	2 ⁻¹	2 ⁻²	2 ⁻³	2 ⁻⁴	2 ⁻⁵	2 ⁻⁶	2 ⁻⁷	2 ⁻⁸

Supply Voltage, TX Bias Current, TX Optical Power, RX Received Power (Unsigned values)

A2H Byte 98 (Vcc MSB)								A2H Byte 99 (Vcc LSB)							
A2H Byte 100 (TX Bias MSB)								A2H Byte 101 (TX Bias LSB)							
A2H Byte 102 (TX Power MSB)								A2H Byte 103 (TX Power LSB)							
A2H Byte 104 (RX Power MSB)								A2H Byte 105 (RX Power LSB)							
2 ¹⁵	2 ¹⁴	2 ¹³	2 ¹²	2 ¹¹	2 ¹⁰	2 ⁹	2 ⁸	2 ⁷	2 ⁶	2 ⁵	2 ⁴	2 ³	2 ²	2 ¹	2 ⁰

The digital value conversions are updated every 13ms (nominal) or 20ms (max) in rotation. After getting digital value, each measurement could be obtained by multiplying digital value by corresponding LSB value:

Temperature = Temp (Digital Value) × LSB_{Temp} = Temp (Digital Value) × 1/256; when Temperature < 128

Temperature = Temp (Digital Value) × LSB_{Temp} = [Temp (Digital Value) × 1/256] - 256; when Temperature ≥ 128

V_{cc} = V_{cc}(Digital Value) × LSB_{Vcc} = V_{cc}(Digital Value) × 100μV

TX Bias Current = TX Bias Current (Digital Value) × LSB_{TX,Bias} = TX Bias Current (Digital Value) × 2μA

TX Power = TX Power (Digital Value) × LSB_{TXPower} = TX Power (Digital Value) × 0.1μW

RX Power = RX Power (Digital Value) × LSB_{RXPower} = RX Power (Digital Value) × 0.1μW

Status Bits and Alarm/Warning Flag Bits (2 Wire Address A2H)

Address	Bit	Name	Description
110	7	TX Disable State	Digital state of TX disable (1) and enabled (0)
110	6	Soft TX Disable	Not implemented
110	5-3	Reserved	
110	2	TX Fault State	1=TX failure state, 0=TX normal state
110	1	LOS	Digital state of LOS output pin. 0=optical signal detected, 1=no optical signal detected
110	0	Data_Ready_Bar	Not implemented.
111	7-0	Reserved	Reserved
112	7	Temp High Alarm	Set when internal temperature exceeds high alarm level.
112	6	Temp Low Alarm	Set when internal temperature is below low alarm level.
112	5	Vcc-High Alarm	Set when internal supply voltage exceeds high alarm level.
112	4	Vcc Low Alarm	Set when internal supply voltage is below low alarm level.
112	3	TX Bias High Alarm	Set when TX Bias current exceeds high alarm level.
112	2	TX Bias Low Alarm	Set when TX Bias current is below low alarm level.
112	1	TX Power High Alarm	Set when TX Power exceeds high alarm level.
112	0	TX Power Low Alarm	Set when TX Power is below low alarm level.
113	7	RX Power High Alarm	Set when Received Power exceeds high alarm level.
113	6	RX Power Low Alarm	Set when Received Power is below low alarm level.
113	5-0	Reserved Alarm	
114-115	All	Reserved	
116	7	Temp High Warning	Set when internal temperature exceeds high warning level.

116	6	Temp Low Warning	Set when internal temperature is below low warning level.
116	5	Vcc High Warning	Set when internal supply voltage >high warning level.
116	4	Vcc Low Warning	Set when internal supply voltage < low warning level.
116	3	TX Bias High Warning	Set when TX Bias current exceeds high warning level.
116	2	TX Bias Low Warning	Set when TX Bias current is below low warning level.
116	1	TX Power High Warning	Set when TX Power exceeds high warning level.
116	0	TX Power Low Warning	Set when TX Power is below low warning level.
117	7	RX Power High Warning	Set when Received Power exceeds high warning level.
117	6	RX Power Low Warning	Set when Received Power is below low warning level.
117	5-0	Reserved Warning	
118-119	All	Reserved	

Vendor Specific and User Accessible EEPROM (2 Wire Address A2H)

Address	# Bytes	Name	Description
120-127	8	Vendor Specific	Don't Access
128-247	120	User writable EEPROM	
248-255	8	Vendor Specific	Don't Access

Recommend Circuit Schematic

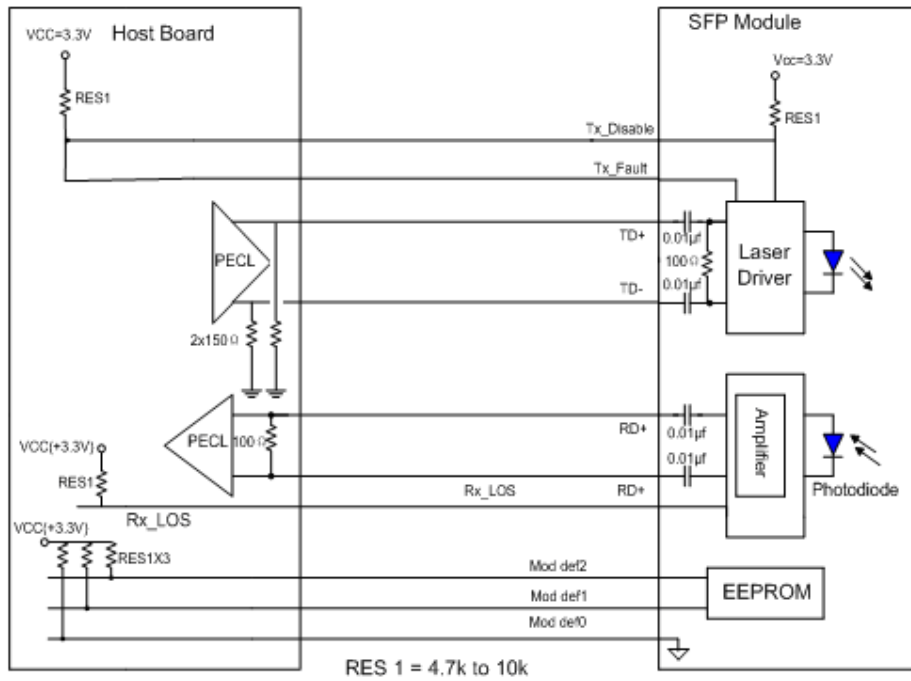

Mechanical Specifications

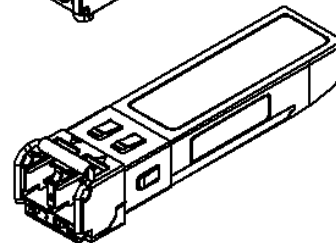
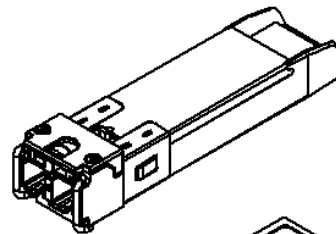
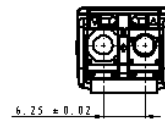
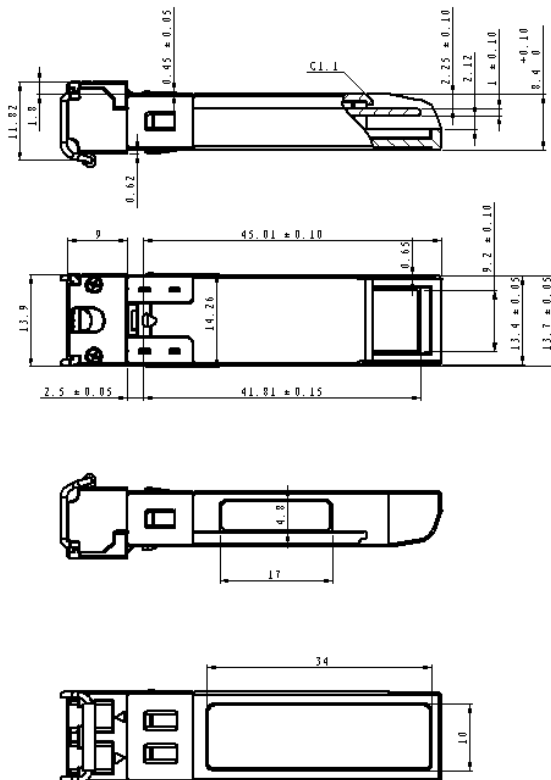

Class 1 Labels

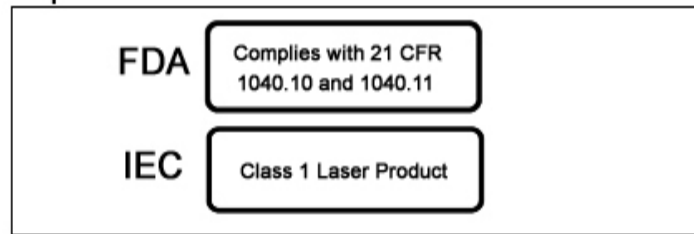

Laser Emission Data

Wavelength	1310nm
Total output power (as defined by FDA: 7mm aperture at 20cm distance)	<0.195mW
Total output power (as defined by IEC: 7mm aperture at 10cm distance)	<15.6mW
Beam divergence	12.5°

Laser Emission

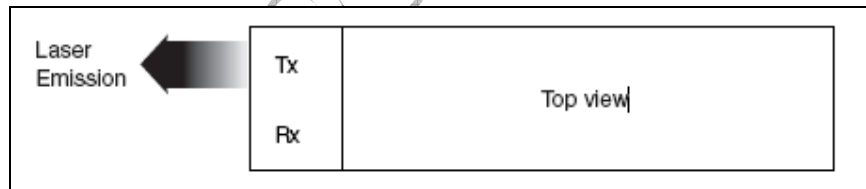

Obtaining Document

You can visit our website:

<http://www.eoptolink.com>

Or contact Eoptolink Technology Inc., Ltd. listed at the end of the documentation to get the latest document.

Revision History

Revision	Initiated	Reviewed	Approved	Release Date
V2.a	Tim.Liang	Kelly.Cao		Apr 20, 2007

Notice:

Eoptolink reserves the right to make changes to or discontinue any optical link product or service identified in this publication, without notice, in order to improve design and/or performance.

Applications that are described herein for any of the optical link products are for illustrative

Eoptolink Technology Inc., Ltd.

purposes only. Eoptolink makes no representation or warranty that such applications will be suitable for the specified use without further testing or modification.

Contact:

Add: Floor 5, Building 2, No. 21 Gaopeng Avenue, High-Tech District, CHENGDU, SICHUAN
610041 P.R. CHINA

Tel: (+86) 028-85122709 ext 816 & 809

Fax: (+86) 028-85121912

Postal: 610041

E-mail: sales@eoptolink.com

<http://www.eoptolink.com>

Eoptolink